

Presentation of the range

The RXM miniature relay range comprises:

- 1 12 A relays with 2 C/O contacts, 10 A relays with 3 C/O contacts, 6 A relays with 4 C/O contacts and 3 A "low level" relays with 4 C/O contacts. All these relays have the same dimensions.
- 2 Sockets with mixed or separate contact terminals.
- 3 Protection modules (diode, RC circuit or varistor). All these modules are common to all sockets.
- 4 A metal maintaining clamp for all sockets.
- 5 A plastic maintaining clamp for all sockets.
- 6 A 2-pole bus jumper that can be used on sockets with separate contact terminals in order to simplify cabling when creating an equipotential link between the coil terminals.
- 7 Clip-in legends for all the sockets except RXZ E2M114.

Relay description

- 1 Spring return pushbutton for testing the contacts (green: \Rightarrow , red: \sim).
- 2 Mechanical "relay status" indicator.
- 3 Removable lock-down door enabling forced maintaining of the contacts for test or maintenance purposes. During operation, this lock-down door must always be in the closed position.
- 4 LED (depending on version) indicating the relay status.
- 5 Removable legend for relay identification.
- 6 Four notches for rail mounting adapter or panel mounting adapter with fixing lugs.
- 7 Eight, eleven or fourteen Faston type pins.
- 8 Area by which the product can be easily gripped.
- 9 Mounting adapter enabling direct mounting of the relay on a panel.
- 10 Mounting adapter enabling direct mounting of the relay on a \perp rail.

Socket description

Sockets with mixed contact terminals (1)

- 1 Connection by screw clamp terminals or connector.
- 2 Fourteen female contacts for the relay pins.
- 3 Location for protection modules.
- 4 Locking components for plastic and metal maintaining clamps.
- 5 Locating slot for mounting on \perp rail with fixing clip.
- 6 Two or four fixing holes for panel mounting.

Sockets with separate contact terminals (2)

- 1 Connection by connector.
- 2 Eight, eleven or fourteen female contacts for the relay pins.
- 3 Location for protection modules.
- 4 Locking components for plastic and metal maintaining clamps.
- 5 Locating slot for mounting on \perp rail with fixing clip.
- 6 Two fixing holes for panel mounting.
- 7 Location for bus jumpers (see mounting on sockets on page 28202/8).

(1) The inputs are mixed with the relay's supply terminals, with the outputs being located on the opposite side of the socket.

(2) The inputs and outputs are separated from the relay supply terminals.

General characteristics

Conforming to standards		IEC/EN 61810-1 (iss. 2), UL 508, CSA C22-2 n° 14
Product certifications		UL, CSA pending
Ambient air temperature around the device	Storage	°C - 40... + 85
	Operation	°C - 40... + 55
Vibration resistance	Conforming to IEC/EN 60068-2-6	> 6 gn (10...50 Hz)
Degree of protection	Conforming to IEC/EN 60529	IP 40
Shock resistance conforming to IEC/EN 60068-2-27	Opening	10 gn
	Closing	5 gn
Protection category		RT I
Mounting position		Any

Insulation characteristics

Rated insulation voltage (Ui)	V	250 (IEC), 300 (UL, CSA)
Rated impulse withstand voltage (Uimp)	kV	3.6 (1.2/50 μs)
Dielectric strength (rms voltage)	Between coil and contact	~ V 2500
	Between poles	~ V 2500
	Between contacts	~ V 1500

Contact characteristics

Relay type		RXM 2AB●●●	RXM 3AB●●●	RXM 4AB●●●	RXM 4GB●●●
Number and type of contacts		2 C/O	3 C/O	4 C/O	4 C/O
Contact materials		AgNi			
Conventional thermal current (Ith)	For ambient temperature ≤ 55 °C	A 12	10	6	3
Rated operational current in utilisation categories AC-1 and DC-1	Conforming to IEC	N/O 12	10	6	2
	Conforming to UL	N/C 6	5	3	1
Maximum operating rate In operating cycles/hour	No-load	18 000			
	Under load	1200			
Switching voltage	Maximum	V	~ / - 250		
Switching capacity	Minimum	mA	10 mA on 17 V		
	Maximum	VA	3000	2500	1500
Utilisation coefficient		20 %			
Mechanical durability	In millions of operating cycles	10			
Electrical durability In millions of operating cycles	Resistive load	0.1			
	Inductive load	See curves below			

Electrical durability of contacts
Resistive load ~

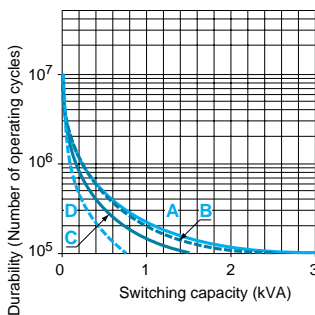

Reduction coefficient for inductive load ~
(depending on power factor cos φ)

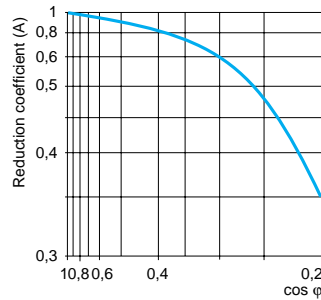

Maximum switching capacity on resistive load ∴

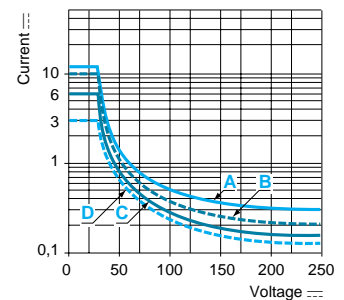

A RXM 2AB●●● **B** RXM 3AB●●● **C** RXM 4AB●●● **D** RXM 4GB●●●

Durability (inductive load) = durability (resistive load) x reduction coefficient.

Coil characteristics

Average consumption		~	VA	1.2								
		≡	W	0.9								
Drop-out voltage threshold		~		≥ 0.15 U _c								
		≡		≥ 0.1 U _c								
Operating time (response time)	Between coil energisation and making of the On-delay contact	~	ms	20								
		≡	ms	20								
	Between coil de-energisation and making of the Off-delay contact	~	ms	20								
		≡	ms	20								
Control circuit voltage U _c			V	12	24	48	110	120	125	220	230	240
Relay control voltage codes				JD	BD	ED	FD	–	GD	MD	–	–
DC	Average resistance at 20 °C ± 10%		Ω	160	650	2600	11 000	–	11 000	14 000	–	–
	Operating voltage limits	Min.	V	9.6	19.2	38.4	88	–	100	176	–	–
Max.		V	13.2	26.4	52.8	121	–	138	242	–	–	
Relay control voltage codes				–	B7	E7	–	F7	–	M7	P7	U7
AC	Average resistance at 20 °C ± 15%		Ω	–	180	770	–	4430	–	15 000	15 000	15 500
	Operating voltage limits	Min.	V	–	19.2	38.4	–	96	–	176	184	192
Max.		V	–	26.4	52.8	–	132	–	242	253	264	

Socket characteristics

Socket type			RXZ E2S108M	RXZ E2S111M	RXZ E2S114M	RXZ E2M114	RXZ E2M114M
Relay types used			RXM 2●●●●●	RXM 3●●●●●	RXM 4●●●●●	RXM 2●●●●●(1) RXM 4●●●●●	RXM 2●●●●●(1) RXM 4●●●●●
Product certifications			UL, CSA (pending)				
Conventional thermal current (I _{th})		A	12	10			
Degree of protection		Conforming to IEC/EN 60529	IP 20				
Connection	Solid cable without cable end	mm ²	1 conductor: 0.5...2.5 mm ² (AWG 20...AWG 12) 2 conductors: 0.5...1.5 mm ² (AWG 20...AWG 14)				
	Flexible cable with cable end	mm ²	1 conductor: 0.2...2.5 mm ² (AWG 24...AWG 14) 2 conductors: 0.2...1.5 mm ² (AWG 24...AWG 16)				
Maximum tightening torque		Nm	0.6 (M3 screw)				
Contact terminal arrangement			Separate				Mixed
Bus jumper I _{th} : 5 A			Yes				No

(1) When mounting relay RXM 2●●●●● on socket RXZ E2M●●●●, the thermal current must not exceed 10 A.

Substitution table

Old ranges		New range
RXN	RXL	RXM
Miniature relays		
RXN 21E1●●●	RXL 2A12B●●●	RXM 2AB●●●
–	RXL 3A10B●●●	RXM 3AB●●●
RXN 41G1●●●	RXL 4A06B●●●	RXM 4AB●●●
–	RXL 4G06B●●●	RXM 4GB●●●
RXN 41G1●●●TQ	RXL 2A12B●●●TQ	RXM 2AB●●●TQ
RXN 21E1●●●TQ	RXL 4A06B●●●TQ	RXM 4AB●●●TQ
Sockets		
RXZ E1M114	RXZ E1M114	RXZ E2M114
RXZ 7G	RXZ 7G	RXZ E2M114M
RXZ E1M114M	RXZ E1M114M	RXZ E2M114M
RXZ E1●1●●M	RXZ E1●1●●M	RXZ E2●1●●M
Protection modules		
RXM 040MD	RXM 040MD	RXM 040W
RZM 040W	RZM 040W	RXM 040W
RZM 031●●	RZM 031●●	RXM 040W (2)
RZM 041●●7	RZM 041●●7	RXM 041●●7
RZM 021●●	RZM 021●●	RXM 021●● (2)
Accessories		
RXZ 200	RXZ 200	RXZ 400
RXZ R235	RXZ R235	RXZ R335
RXZ L320	RXZ L320	RXZ L420

(2) Δ Protection module without LED.

Zelio Relay - plug-in relays

RXM miniature relays

535189



RXM AB2F7

Miniature relays without LED (sold in lots of 10)						
Control circuit voltage	Number and type of contacts - Thermal current (Ith)					
	2 C/O - 12 A		3 C/O - 10 A		4 C/O - 6 A	
	Unit reference	Weight	Unit reference	Weight	Unit reference	Weight
V		kg		kg		kg
≡ 12	RXM 2AB1JD	0.037	RXM 3AB1JD	0.038	RXM 4AB1JD	0.036
≡ 24	RXM 2AB1BD	0.037	RXM 3AB1BD	0.038	RXM 4AB1BD	0.036
≡ 48	RXM 2AB1ED	0.037	RXM 3AB1ED	0.038	RXM 4AB1ED	0.036
≡ 110	RXM 2AB1FD	0.037	RXM 3AB1FD	0.038	RXM 4AB1FD	0.036
≡ 220	-	-	-	-	RXM 4AB1MD	0.036
~ 24	RXM 2AB1B7	0.037	RXM 3AB1B7	0.038	RXM 4AB1B7	0.036
~ 48	RXM 2AB1E7	0.037	RXM 3AB1E7	0.038	RXM 4AB1E7	0.036
~ 120	RXM 2AB1F7	0.037	RXM 3AB1F7	0.038	RXM 4AB1F7	0.036
~ 230	RXM 2AB1P7	0.037	RXM 3AB1P7	0.038	RXM 4AB1P7	0.036
~ 240	-	-	-	-	RXM 4AB1U7	0.036

Miniature relays with LED (sold in lots of 10)						
Control circuit voltage	Number and type of contacts - Thermal current (Ith)					
	2 C/O - 12 A		3 C/O - 10 A		4 C/O - 6 A	
	Unit reference	Weight	Unit reference	Weight	Unit reference	Weight
V		kg		kg		kg
≡ 12	RXM 2AB2JD	0.037	RXM 3AB2JD	0.038	RXM 4AB2JD	0.036
≡ 24	RXM 2AB2BD	0.037	RXM 3AB2BD	0.038	RXM 4AB2BD	0.036
≡ 48	RXM 2AB2ED	0.037	RXM 3AB2ED	0.038	RXM 4AB2ED	0.036
≡ 110	RXM 2AB2FD	0.037	RXM 3AB2FD	0.038	RXM 4AB2FD	0.036
≡ 125	-	-	-	-	RXM 4AB2GD	0.036
~ 24	RXM 2AB2B7	0.037	RXM 3AB2B7	0.038	RXM 4AB2B7	0.036
~ 48	RXM 2AB2E7	0.037	RXM 3AB2E7	0.038	RXM 4AB2E7	0.036
~ 120	RXM 2AB2F7	0.037	RXM 3AB2F7	0.038	RXM 4AB2F7	0.036
~ 230	RXM 2AB2P7	0.037	RXM 3AB2P7	0.038	RXM 4AB2P7	0.036

535189



RXM 4GB2F7

Miniature relays with low level contacts, without LED (sold in lots of 10)			
Control circuit voltage	Number and type of contacts - Thermal current (Ith)		
	4 C/O - 3 A		
	Unit reference	Weight	
V		kg	
≡ 12	RXM 4GB1JD	0.036	
≡ 24	RXM 4GB1BD	0.036	
≡ 48	RXM 4GB1ED	0.036	
≡ 110	RXM 4GB1FD	0.036	
~ 24	RXM 4GB1B7	0.036	
~ 48	RXM 4GB1E7	0.036	
~ 120	RXM 4GB1F7	0.036	
~ 230	RXM 4GB1P7	0.036	

Miniature relays with low level contacts, with LED (sold in lots of 10)			
Control circuit voltage	Number and type of contacts - Thermal current (Ith)		
	4 C/O - 3 A		
	Unit reference	Weight	
V		kg	
≡ 12	RXM 4GB2JD	0.036	
≡ 24	RXM 4GB2BD	0.036	
≡ 48	RXM 4GB2ED	0.036	
≡ 110	RXM 4GB2FD	0.036	
~ 24	RXM 4GB2B7	0.036	
~ 48	RXM 4GB2E7	0.036	
~ 120	RXM 4GB2F7	0.036	
~ 230	RXM 4GB2P7	0.036	
~ 240	RXM 4GB2U7	0.036	

535205

RXZ E2M114M
+
Relay RXM 4AB2P7TQ

Miniature relays without LED (sold in lots of 100)

Control circuit voltage	Number and type of contacts - Thermal current (Ith)		4 C/O - 6 A	
	2 C/O - 12 A	Weight	Unit reference	Weight
V		kg		kg
--- 12	—	—	RXM 4AB1JDTQ	0.036
--- 24	RXM 2AB1BDTQ	0.037	RXM 4AB1BDTQ	0.036
--- 48	—	—	RXM 4AB1EDTQ	0.036
--- 110	—	—	RXM 4AB1FDTQ	0.036
--- 220	—	—	RXM 4AB1MDTQ	0.036
~ 24	RXM 2AB1B7TQ	0.037	RXM 4AB1B7TQ	0.036
~ 48	—	—	RXM 4AB1E7TQ	0.036
~ 120	RXM 2AB1F7TQ	0.037	RXM 4AB1F7TQ	0.036
~ 230	RXM 2AB1P7TQ	0.037	RXM 4AB1P7TQ	0.036

Miniature relays with LED (sold in lots of 100)

--- 24	—	—	RXM 4AB2BDTQ	0.036
~ 24	RXM 2AB2B7TQ	0.037	RXM 4AB2B7TQ	0.036
~ 230	RXM 2AB2P7TQ	0.037	RXM 4AB2P7TQ	0.036

Sockets

Contact terminal arrangement	Connection	Relay type	Sold in lots of	Unit reference	Weight kg
Mixed	Screw clamp terminals	RXM 2●●●●(3) RXM 4●●●●	10	RXZ E2M114 (1)	0.048
	Connector	RXM 2●●●●(3) RXM 4●●●●	10	RXZ E2M114M (1)	0.056
Separate	Connector	RXM 2●●●●	10	RXZ E2S108M (2)	0.058
		RXM 3●●●●	10	RXZ E2S111M (1)	0.066
		RXM 4●●●●	10	RXZ E2S114M (1)	0.070

Protection modules

Description	Voltage	For use with	Sold in lots of	Unit reference	Weight kg
	V				kg
Diode	--- 6...250	All sockets	20	RXM 040W	0.003
RC circuit	~ 24...60	All sockets	20	RXM 041BN7	0.010
	~ 110...240	All sockets	20	RXM 041FU7	0.010
Varistor	~ 6...24	All sockets	20	RXM 021RB	0.030
	~ 24...60	All sockets	20	RXM 021BN	0.030
	~ 110...240	All sockets	20	RXM 021FP	0.030

Timing relays

Description	For use with	Unit reference	Weight kg
2 or 4 timed C/O contacts (function A)	Sockets RXZ E●●●●●	RE XL2●● (4) RE XL4●● (4)	— —

Accessories

Description	For use with	Sold in lots of	Unit reference	Weight kg
Metal maintaining clamp	All sockets	10	RXZ 400	0.001
Plastic maintaining clamp	All sockets	10	RXZ R335	0.005
Bus jumper, 2-pole (Ith: 5 A)	All sockets with separate contacts	10	RXZ S2	0.005
Mounting adapter for 15 rails (5)	All relays	10	RXZ E2DA	0.004
Mounting adapter with fixing lugs for panel	All relays	10	RXZ E2FA	0.002
Clip-in legends	All relays (sheet of 108 legends)	10	RXZ L520	0.080
	All sockets except RXZ E2M114	10	RXZ L420	0.001

(1) Thermal current Ith: 10 A

(2) Thermal current Ith: 12 A

(3) When mounting relay RXM 2●●●●● on socket RXZ E2M●●●●●, the thermal current must not exceed 10 A.

(4) Please consult the "Zelio Time timing relays" catalogue.

(5) Test button becomes inaccessible.

535211

RXZ E2S114M
+
Relay RXM 4AB2F7

535212



RXM 041●●7

535195



RE XL4●●

535215



RXZ 400

Dimensions

Miniature relays

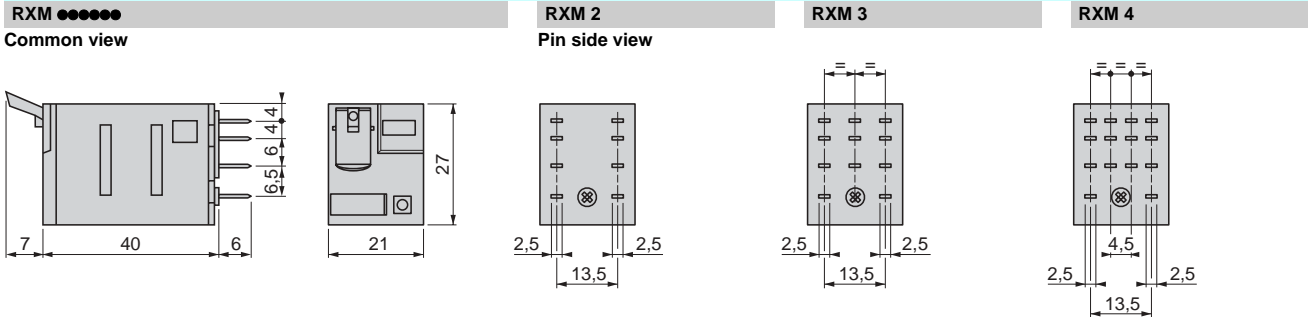

Sockets

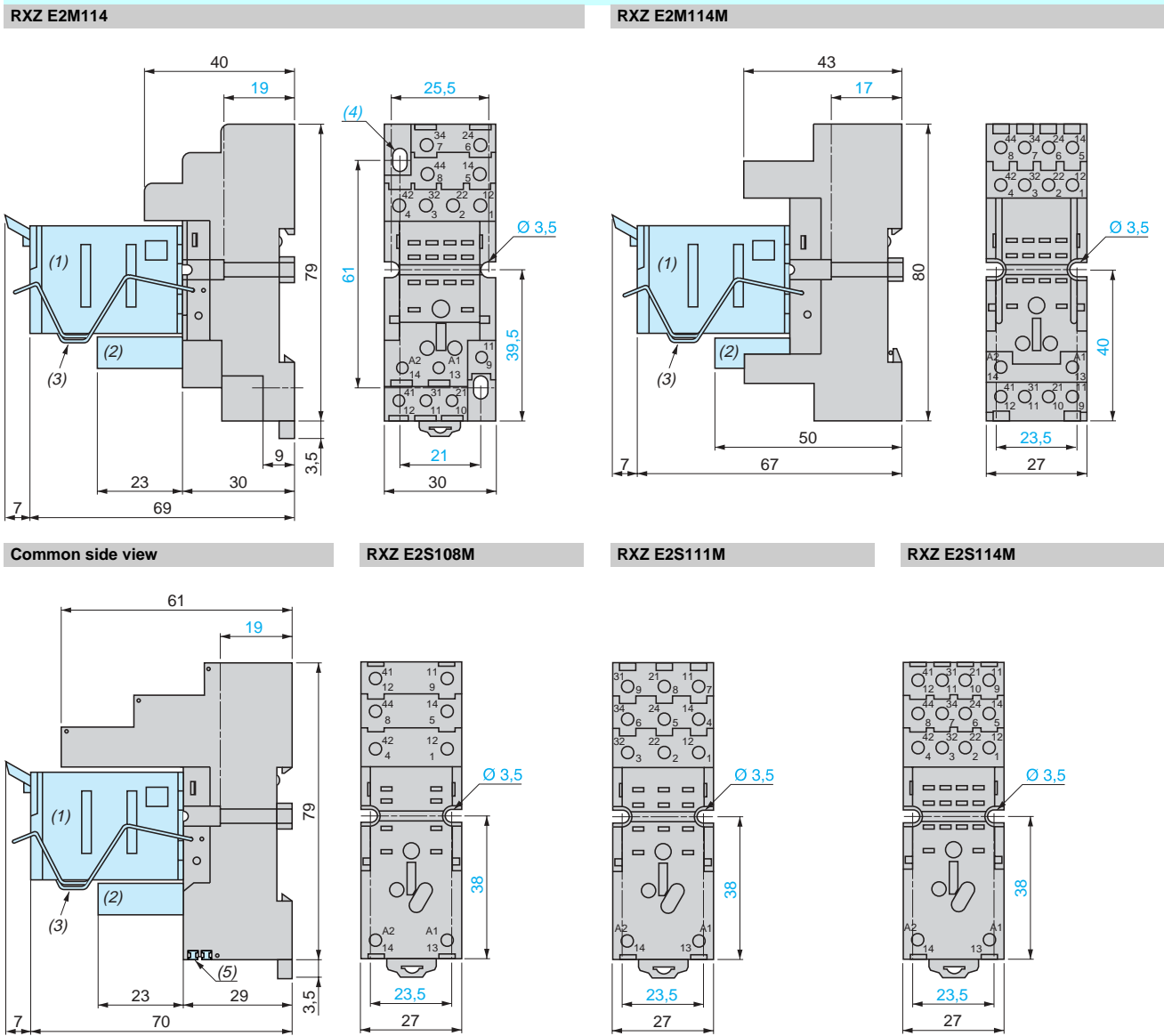

- (1) Relays
- (2) Add-on protection module
- (3) Maintaining clamp
- (4) 2 elongated holes $\varnothing 3.5 \times 6.5$
- (5) 2 bus jumpers

Dimensions (continued)

Plastic clamp and clip-in legends

RXZ R335

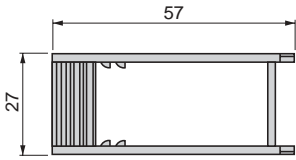

RXZ L420

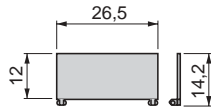

Mounting on all sockets (1)

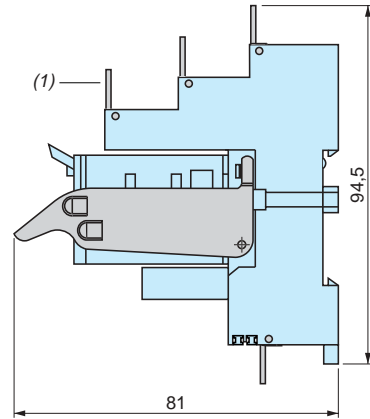

(1) Clip-in legends for all sockets except RXZ E2M114.

Bus jumper

RXZ S2

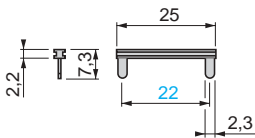

Mounting on sockets with separate contacts (view from below)

Example of bus jumper mounting on sockets

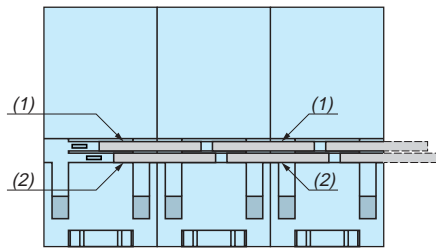

(1) 2 bus jumpers (polarity A2)
(2) 2 bus jumpers (polarity A1)

Metal clamp

RXZ 400

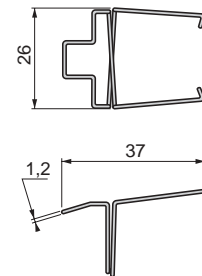

Mounting adapter for rail (1)

RXZ E2DA

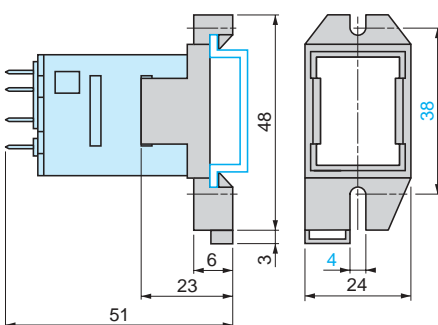

Mounting adapter for panel

RXZ E2FA

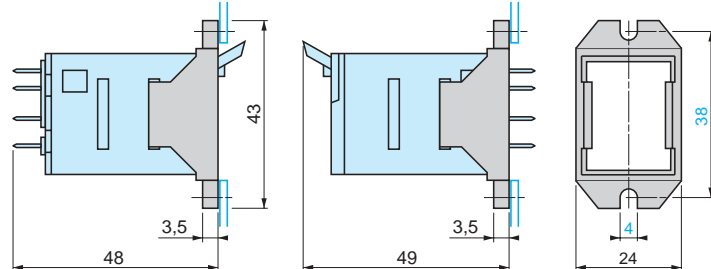

(1) Test button becomes inaccessible

Schemes

Miniature relays

RXM 2●●●●●

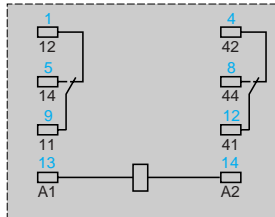
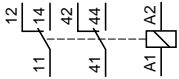

RXM 3●●●●●

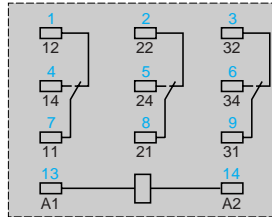
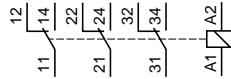

RXM 4●●●●●

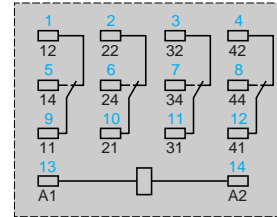
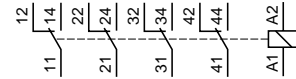

Symbols shown in blue correspond to Nema marking.